

MM50



EN 1495



- Machinery Directive
2006/42/CE
- Electromagnetic Compatibility Directive
89/336/EC.
- Low Voltage Directive
73/23/EC
- Safety of machinery
EN ISO 12100
- Safety of machinery – Electrical equipment of machines – Part 1 : General requirements
EN 60204-1

LOADS AND CONFIGURATIONS

SINGLE MAST

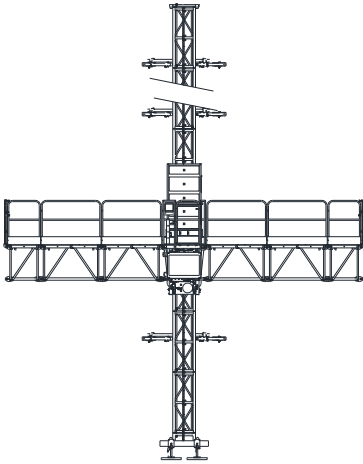

TWIN MAST

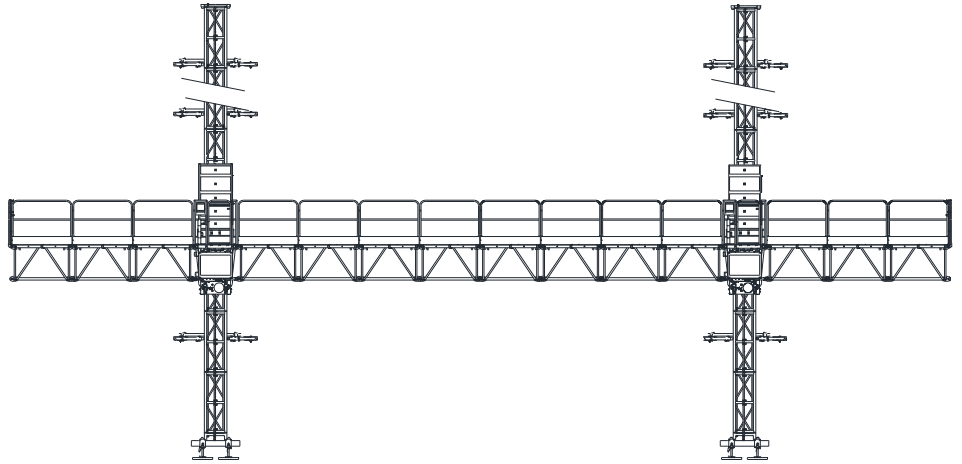

SINGLE MAST

L (m)	Total Length Configuration	Total Service Load Q (kg)	
		1m	
11,8		1300	1450
10,1		1500	1650
7,1		1900	1950
4,1		2200	2250
2,8		2400	2400

TWIN MAST

L (m)	Total Length Configuration	Total Service Load Q (kg)	
		1m	
34,7		1600	2050
30,7		2080	2480
24,7		2800	3120
20,2		3340	3590
15,7		3880	4070
9,7		4600	4705
6,7		4000	5023

Interchangeable mast sections with other Motto's machines: MH20 - MTP20 - ML20

Load must be evenly distributed over the whole length of the platform.

Other available configurations : contact Motto Elevation S.L.

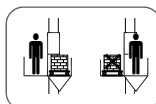

Extensions are for the exclusive use of workers. Never place any load on an extension.

TECHNICAL CHARACTERISTICS

GENERAL DATA	SINGLE MAST	TWIN MAST
Lifting speed	6 m/min / 10 m/min	
Maximum height	200 m	
Max. distance between anchors	12 m	
Freestanding maximum height	9 m	
Maximum platform length	11,8 m	34,7 m
Max. distance between mast axis	-	21,6 m
Platform width	1,3 m	
Max. telescopic extensions width	1 m / 1,75 m / 2,5 m	
Decks (without floor)	0,83m = 55 kg / 1,5 m =80 kg	
Mast section	Square 560 x 560mm x 1,5m - 80 kg	
Drive unit weight (without stabilizers)	1100 kg	
Maximum wind speed	Anchored = 55 km/h Freestanding / installation = 45 km/h	
Temperature range	-10 / +55 degrees Celsius	
Noise level in service	< 80 Db (A) IEC51	
Main components hot dip galvanized		





For other required characteristics, contact Motto Elevation S.L.

ELECTRICAL DATA

Power supply (*)	400V (±5%) – 50Hz – 3ph+N+E
Hand tools power supply (*)	230V and 16A – 50Hz – 1ph+N+E
Control voltage	48 VAC
Motors power (per drive unit)	6 m/min = 2 x 1,85 kw 10 m/min = 2 x 4 kw
Min. required power (per drive unit)	6 m/min = 6 kw 10 m/min = 9 kw
Nominal current (per drive unit)	6 m/min = 9 A 10 m/min = 14 A
Starting current (per drive unit)	6 m/min = 43 A 10 m/min = 70 A
Min. three phase generator (per drive unit)	6 m/min = 25 KVA 10 m/min = 40 KVA

(*) Other power supplies available (voltage and 60 Hz frequency) according to national conditions of power supply

MAIN OPTIONALS DEVICES

			
OPERATION	SAFETY	TOOLS	APPLICATION
Reinforced mast	Overload device	Jib	Cold climate
Corner kit	Parachute	Manual winch	High temperatures
Mobile base	Obstacle detection device	Erection tool set	Explosion proof
Drive unit extensions	Communication device		Offshore / Marine proof
Inclined base and platform			Special materials
Special higher dimensions			

MAIN SAFETY DEVICES

STANDARD MECHANICAL SAFETIES
2 motors with gearbox and electromechanical brakes
2 centrifugal brakes per drive unit
Floating motor plate
Automatic self levelling in twin mast
Emergency descent
Top and bottom stops with buffers
Mast protector
Anti slippery floor
Motor protecting cover
Metallic railing and telescopic railing on sides

STANDARD ELECTRICAL SAFETIES
Interlocking device on access door
Top, bottom and emergency stops
Rack detector
Emergency stops
Low voltage control
Movement acoustic buzzer
Right / left drive unit selector
Phases control relay
Emergency stop pushbuttons at control panel and drive units
Delayed starting, with acoustic signalling



Motto Elevation S.L.

T. +34 943 100 123

S motto.elevation

Pol. Bulandegi, 6

20150 Aduna (Gipuzkoa) Spain

www.mottoelevation.com

motto@mottoelevation.com